

9210 Pressure Balanced Thermostatic Shower Mixer



APPLICATION

Suitable for domestic bathroom outlets, photo labs, hair dressing salons or food processing. For use anywhere a constant temperature is required. Shower mixer comes with 15mm BSP hand shower connection.

INSTALLATION

The valve is fitted with 19mm BSP connection nuts and requires pipework to be set at 150-153 c/c.

FEATURES

- Thermostatic temperature control and pressure balancing control in one cartridge.
- "Child" safety lock prevents unintentional temperature increases.
- No more unpleasant showers, always a constant temperature + or -1°C.
- Factory pre-set to 38°C (can be re-calibrated by plumber).
- Comes with check valves and line strainers.
- Operates from Min 50kPa to Max 1000kPa.
- Recommended working pressure 100kPa to 700kPa.
- 10 year warranty on cartridge.
- Made in Sweden.

OPTIONS

Refer to Optional Items and Accessories for details.

COLOURS

Chrome

APPROVALS AS4032

Manufactured in DR brass

CODES

9210-7070

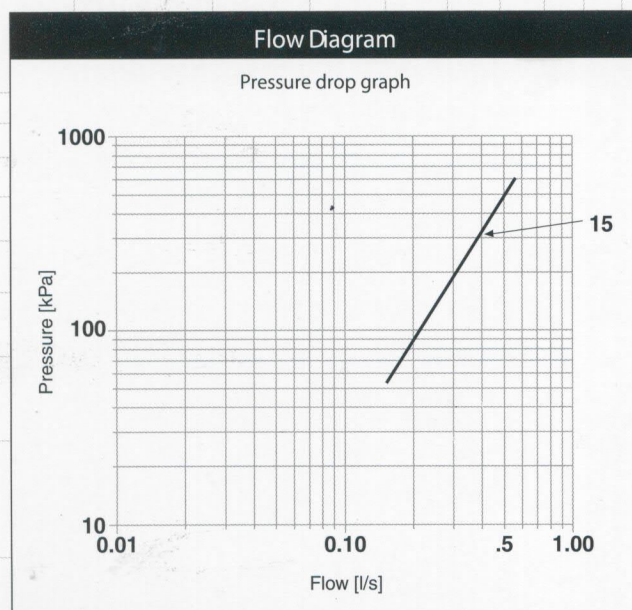
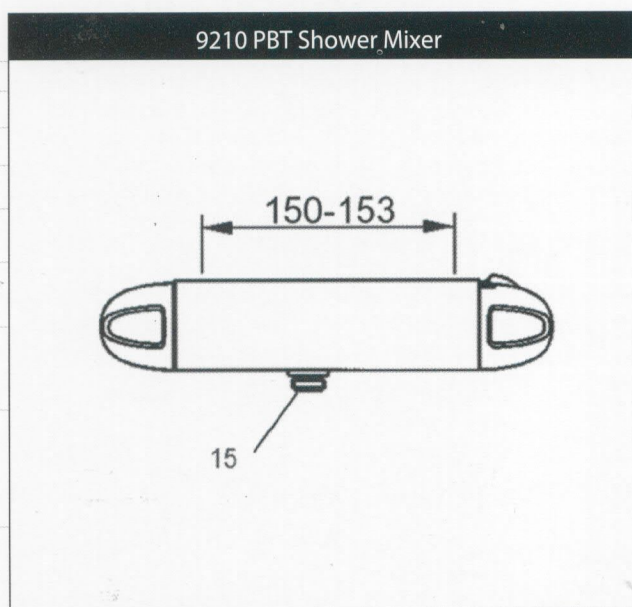

Flow Table	
Pressure(kPa)	Flow (l/min)
100	14
200	20
300	24
400	27
500	31
600	34